

Placa de cocción - Placa de Inducción Modular

Placa de inducción

Código: 7361 270

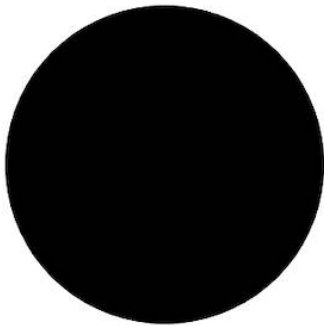

DETALLES

Borde Instalación

Enrasado | FTS

Colorante

Negro

Material

Vitrocerámica

Alimentación

Monofásico: 230 V; 1P + N; Bifásico 400 V; 2P + N; 50.60 Hz

Dimensiones

Ø 270 mm

Descripción completa

Placa de inducción Ø 270 mm - negro - para Sistema Modular Induction

Elemento precalentamiento

1 zona

Potencia total

1.100 (1.400)* W

Ajustes

9 ajustes de potencia por zona + Powerboost

Seguridad

Dotación de seguridad

Tipología

Placa de inducción

Tipo de mandos

Touch control

Notas:

* Powerboost

Notas:

DIBUJOS TÉCNICOS

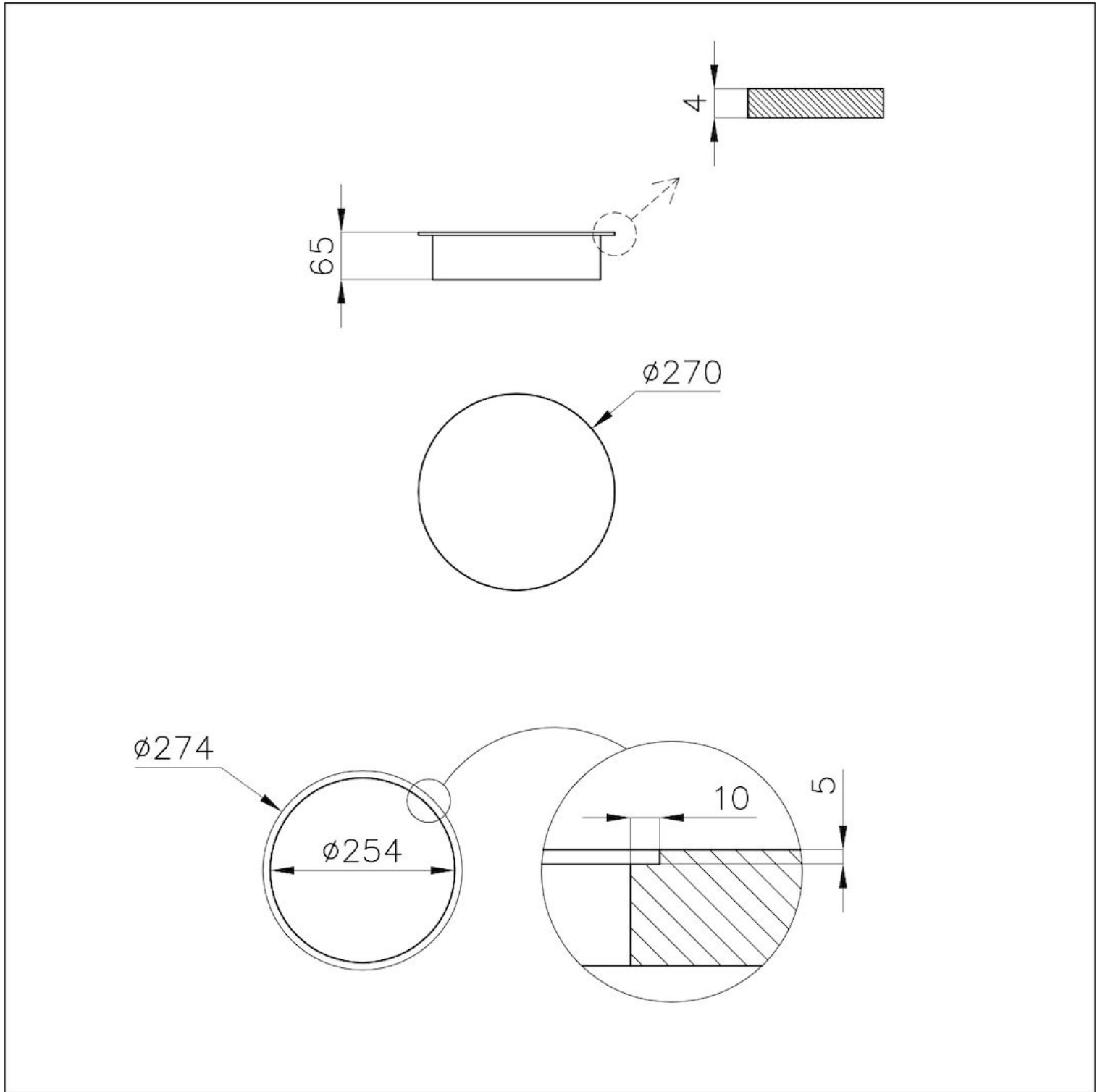

GALERÍA



MARIDAJE RECOMENDADO



**Modular Induction - Caja de
Conexión**
7369 040



**Modular Induction - Caja de
Conexión**
7369 030



**Modular Induction - Caja de
Conexión**
7369 020



**Placa de cocción Touch Control
Modular Induction**
7368 040

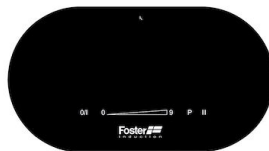

**Placa de cocción Touch Control
Modular Induction**
7368 030



**Placa de cocción Touch Control
Modular Induction**
7368 020